

SiC SBD P3D06016I2

650V SiC Schottky Diode

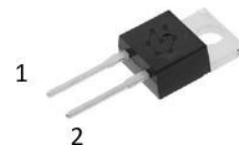

Features

- Qualified to AEC-Q101
- Ultra-Fast Switching
- Zero Reverse Recovery Current
- High-Frequency Operation
- Positive Temperature Coefficient on V_F
- Full Isolated Package for Direct Heat Sinking
- High Surge Current
- 100% UIS Tested

TO-220I-2

Cathode	1
Anode	2



Standards Benefits

- Improve System Efficiency
- Reduction of Heat Sink Requirement
- Essentially No Switching Losses
- Parallel Devices Without Thermal Runaway



Application

- Consumer SMPS
- Boost Diodes in PFC or DC/DC Stages
- AC/DC Converters



Order Information

Part Number	Package	Marking
P3D06016I2	TO-220I-2	P3D06016I2



Contents

Features.....	1
Standards Benefits	1
Application.....	1
Order Information	1
Contents.....	2
1. Maximum Ratings.....	3
2. Electrical Characteristics	4
3. Thermal Characteristics.....	4
4. Typical Performance	5
5. Package Outlines.....	6

PNJ Preliminary

1. Maximum Ratings

At $T_J = 25^\circ\text{C}$, unless specified otherwise

Parameter	Symbol	Value	Unit	Test condition
Repetitive Peak Reverse Voltage	V_{RRM}	650	V	$T_C = 25^\circ\text{C}$
Surge Peak Reverse Voltage	V_{RSM}	650	V	$T_C = 25^\circ\text{C}$
DC Blocking Voltage	V_R	650	V	$T_C = 25^\circ\text{C}$
Forward Current	I_F	28 16	A	$T_C = 25^\circ\text{C}$ $T_C = 100^\circ\text{C}$
Non-Repetitive Forward Surge Current	I_{FSM}	120 100	A	$T_C = 25^\circ\text{C}, t_p = 10\text{ms}$ $T_C = 125^\circ\text{C}, t_p = 10\text{ms}$
Repetitive Peak Forward Surge Current	I_{FRM}	54 23	A	$T_C = 25^\circ\text{C}, t_p = 10\text{ms}$ $T_C = 125^\circ\text{C}, t_p = 10\text{ms}$
Power Dissipation	P_{tot}	47	W	$T_C = 25^\circ\text{C}$
Operating Junction and Storage Temperature	T_J, T_{STG}	-55 to +175	$^\circ\text{C}$	
TO-220 Mounting Torque M3 Screw	T_{orq}	1 8.8	N*m lbf-in	

2. Electrical Characteristics

At $T_J = 25^\circ\text{C}$, unless specified otherwise

Parameter	Symbol	Values			Unit	Test condition
		Min.	Typ.	Max.		
Forward Voltage	V_F	/	1.39	1.6	V	$I_F = 16\text{A}, T_J = 25^\circ\text{C}$
			1.65	/		$I_F = 16\text{A}, T_J = 175^\circ\text{C}$
Reverse Current	I_R	/	18.2	45	μA	$V_R = 650\text{V}, T_J = 25^\circ\text{C}$
			516	/		$V_R = 650\text{V}, T_J = 175^\circ\text{C}$
Total Capacitance	C	/	706	/	pF	$V_R = 0\text{V}, T_J = 25^\circ\text{C}$ $f = 1\text{MHz}$
			72			$V_R = 200\text{V}, T_J = 25^\circ\text{C}$ $f = 1\text{MHz}$
			54			$V_R = 400\text{V}, T_J = 25^\circ\text{C}$ $f = 1\text{MHz}$
Total Capacitive Charge	Q_C	/	38	/	nC	$V_R = 400\text{V}, I_F = 16\text{A}$ $di/dt = 500\text{A}/\mu\text{s}$ $T_J = 25^\circ\text{C}$

3. Thermal Characteristics

Parameter	Symbol	Values	Unit
Thermal Resistance from Junction to Case	$R_{\theta JC}$	3.18	$^\circ\text{C}/\text{W}$

4. Typical Performance

At $T_J = 25^\circ\text{C}$, unless specified otherwise

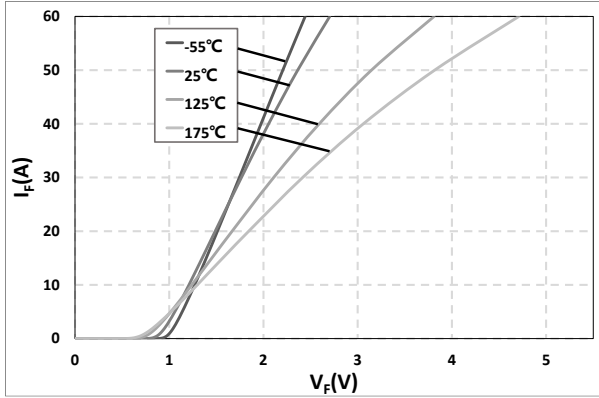

Fig. 1 Typical Forward Characteristics
 $I_F = f(V_F)$; $T_J = -55^\circ\text{C}, 25^\circ\text{C}, 125^\circ\text{C}, 175^\circ\text{C}$

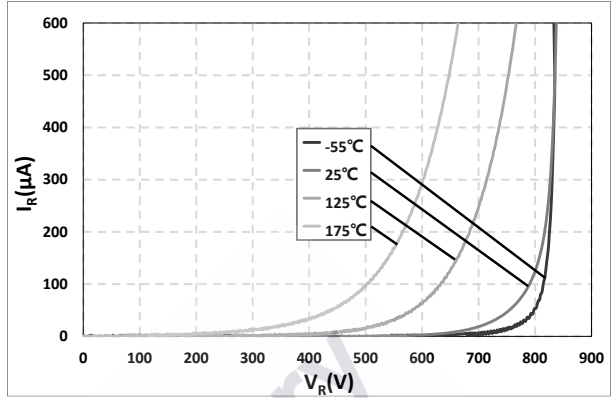

Fig. 2 Reverse Characteristics
 $I_R = f(V_R)$; $T_J = -55^\circ\text{C}, 25^\circ\text{C}, 125^\circ\text{C}, 175^\circ\text{C}$

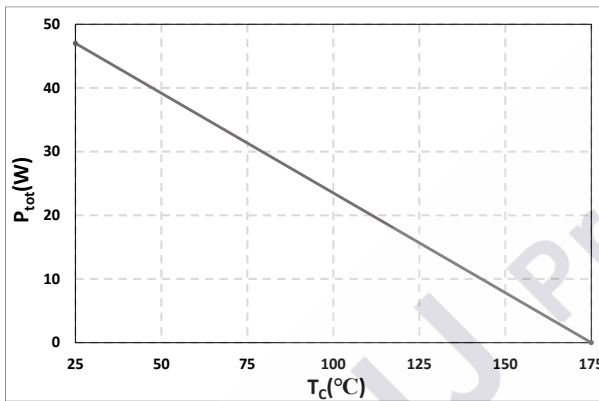

Fig. 3 Typical Power Derating
 $P_{tot} = f(T_c)$

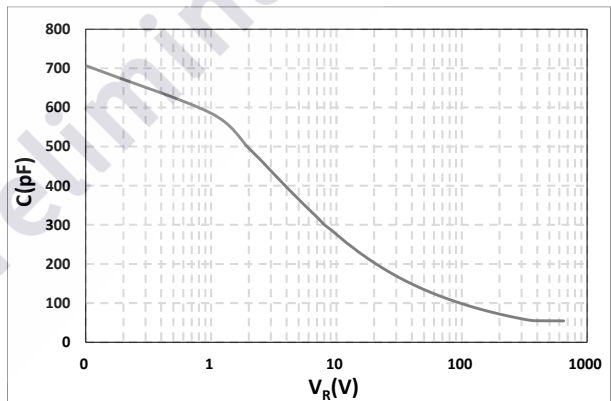

Fig. 4 Typical Total Capacitance
 $C = f(V_R)$

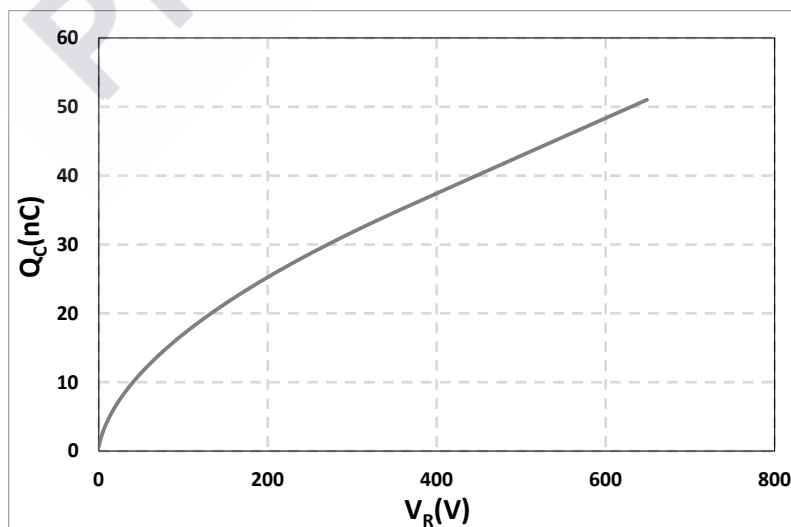
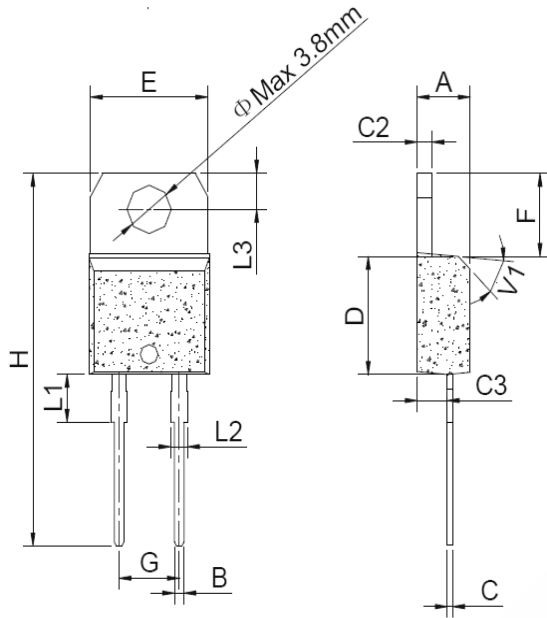

Fig. 5 Typical Total Capacitive Charge
 $Q_C = f(V_R)$

5. Package Outlines



Ref.	Dimensions					
	Millimeters			Inches		
	Min.	Typ.	Max.	Min.	Typ.	Max.
A	4.40		4.60	0.173		0.181
B	0.61		0.88	0.024		0.035
C	0.46		0.70	0.018		0.028
C2	1.21		1.32	0.048		0.052
C3	2.40		2.72	0.094		0.107
D	8.60		9.70	0.339		0.382
E	9.80		10.4	0.386		0.409
F	6.55		6.95	0.258		0.274
G		5.08			0.1	
H	28.0		29.8	1.102		1.173
L1		3.75			0.148	
L2	1.14		1.70	0.045		0.067
L3	2.65		2.95	0.104		0.116
V1		45°			45°	

Drawing and dimensions

PNJ Preliminary